

## Sink Happy Hour Gun Metal 49" x 20" – U/M



Kitchen Sinks

Code: 1049 956

PVD Gun Metal coloring

AISI 304 Stainless steel

Satin finish

Undermount

x cross bending for easy water draining



### DETAILS

**Series** Happy Hour

**Coloring** Gun Metal

**Finish** Satin finish

**Finish** PVD

**Material** AISI 304 stainless steel

**Thickness** 16 Gauge (1.5 mm)

**Inset type** Undermount

**Overall dimensions** 48 <sup>5</sup>/<sub>8</sub>" x 19 <sup>13</sup>/<sub>16</sub>"

Bowls dimensions	1 bowl 46 <sup>5/8"</sup> x 15 <sup>3/4"</sup>
Bowls depth	10"
Cut out	46 <sup>5/8"</sup> x 18 <sup>3/4"</sup>
Cut out warning	The specified cutout size is for POSITIVE REVEAL. This makes it possible to use all the foreseen levels for the accessories. In case of cutout at ZERO REVEAL, there would be no possibility to use the levels 0 and 1
Waste fitting type	3 <sup>1/2"</sup> - with stainless steel basket
Bowls bottom	X cross bending for easy water draining
Underside	Protected with heavy duty undercoating
Fixing system	Undermount fixing kit (brass insert and clips)

## FEATURES

Diamond-shape bottom	The draining of water is an important feature in a sink, and it's always taken good care of in Foster products. In the bent-welded sinks, which would have a flat bottom, the proper draining is guaranteed by the elegant beveling, which helps the water flow.
High thickness	1.5 mm thick steel. A significant thickness, which guarantees the maximum sturdiness and durability.
Basket 3,5" waste fitting	The drain is equipped with a large 3.5" drain, with the practical basket cap that prevents the discharge of solid parts.

## Triple recess - sliding accessories

The Foster Milano sink has an ingenious design that makes it simple to use a large set of optional accessories. On the topmost supporting step, the innovative Black grids slide, creating a large and practical surface to rinse food and crockery. The second step is meant to support and allow the sliding of a complete combination of accessories, which make some operations practical and safe: rinse, drain, slice, grate... everything can be done inside the sink. The third supporting step is on the bottom of the bowl. On this step one can rest the Black grids, making it possible to rinse foodstuffs without their coming in contact with the bottom of the sink, which may be dirty.

## TECHNICAL DATA

Cutout for positive reveal (see Details)

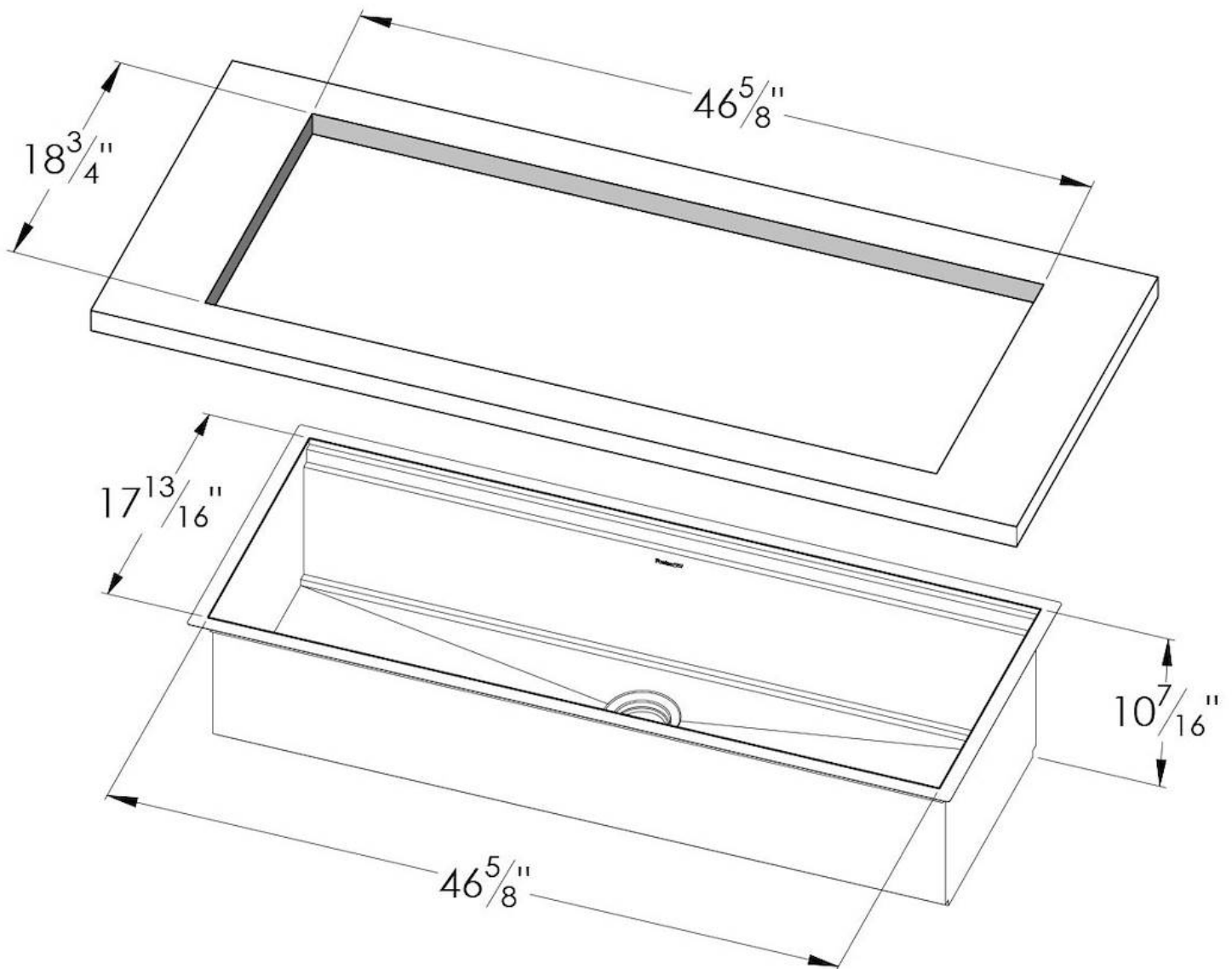

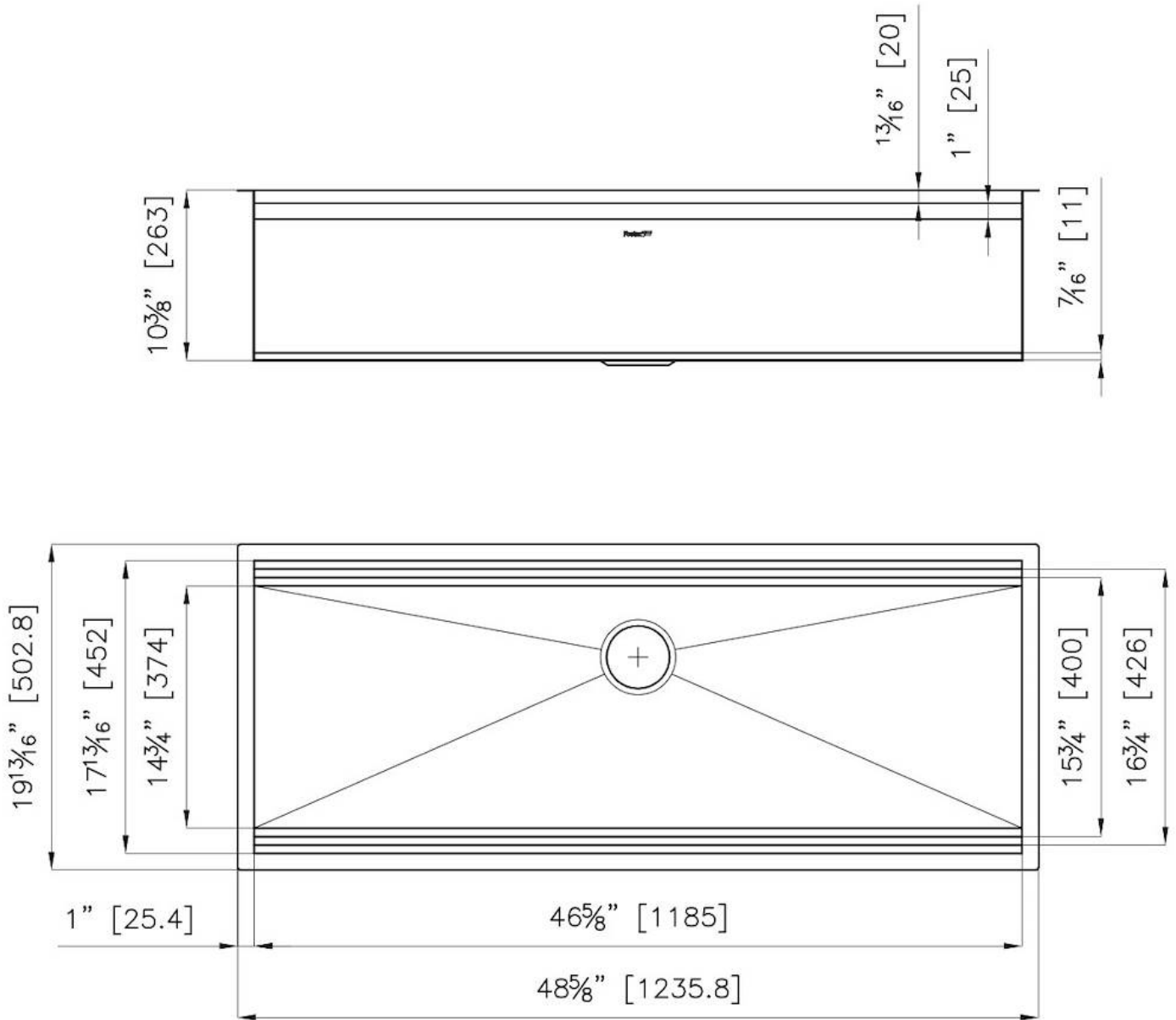

## Happy Hour Optional accessories

The "rails" system makes it possible to use a combination of numerous accessories. Grids, chopping boards, utensils' ranging system, bowls and containers of different dimensions can be alternated in the workspace with a simple gesture, and can easily be stacked, in order to be on hand at all times.

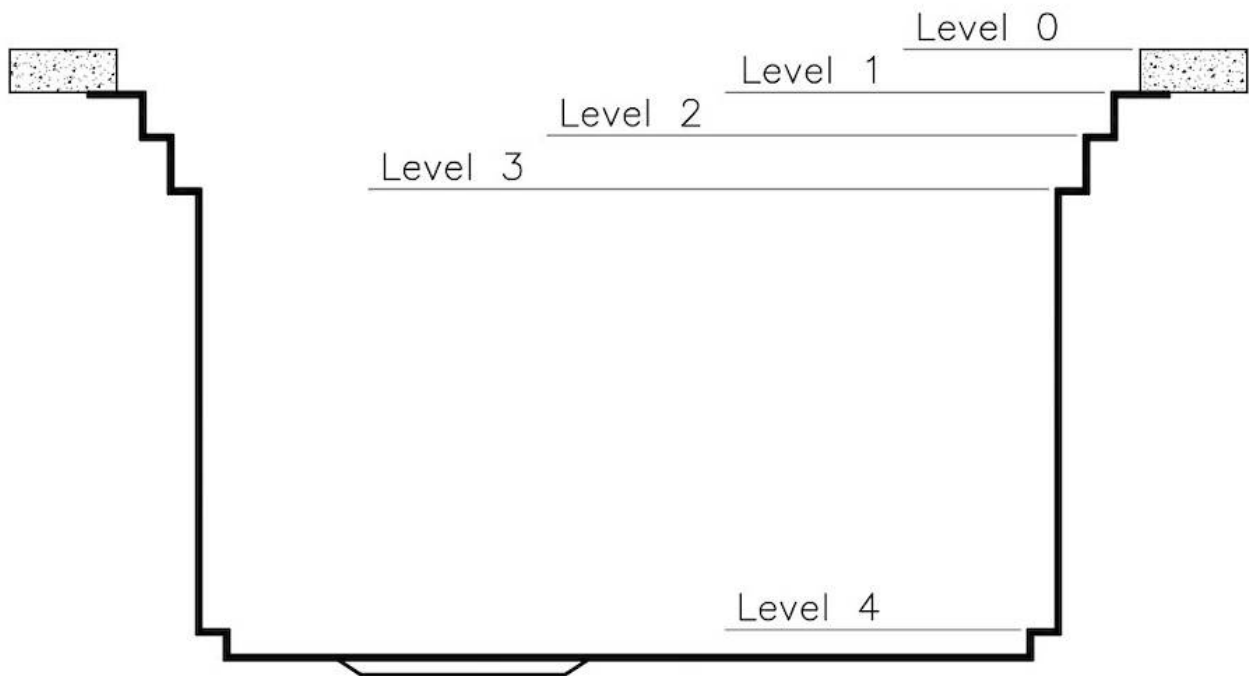

## Happy Hour Level 0

Compatible accessories:

8200 002

8200 601



## Happy Hour Level 1

Compatible accessories:

8100 625

8100 626

8100 627

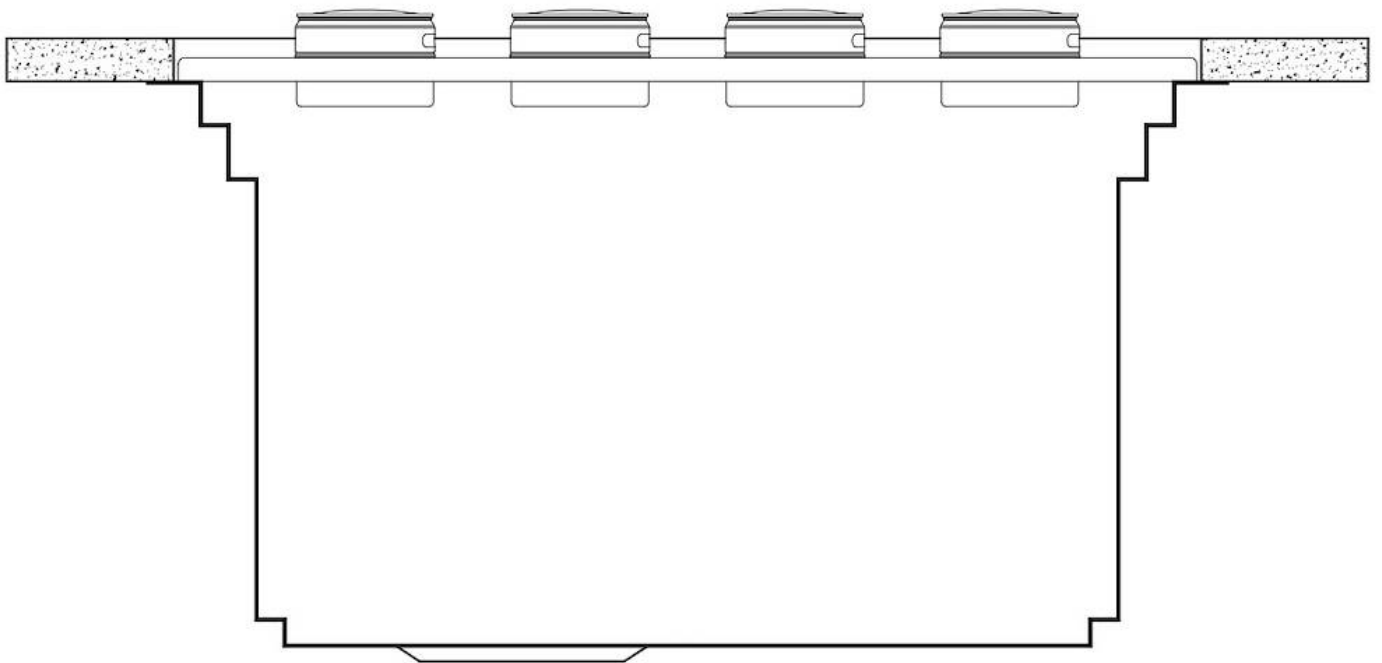

## Happy Hour Level 2

Compatible accessories:

8100 600  
8100 620  
8100 621  
8100 622  
8100 628  
8642 000

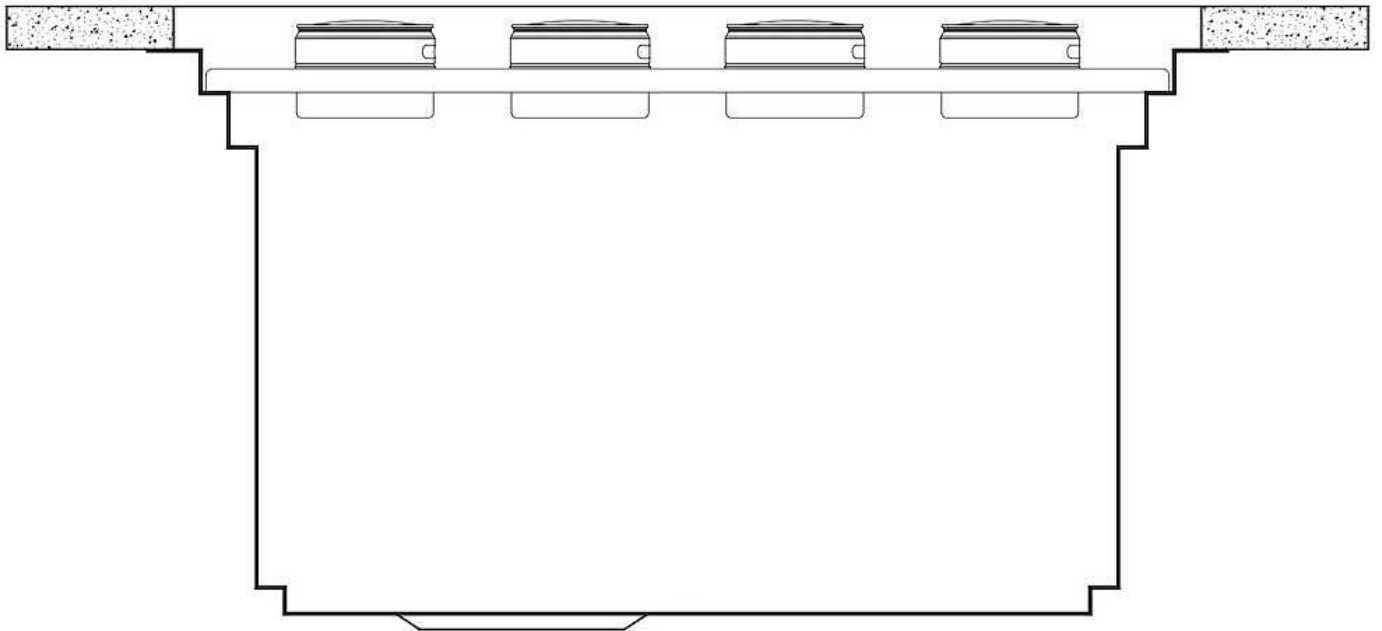



## Happy Hour Level 3

Compatible accessories:

8644	101
8153	100
8631	300
8200	002
8200	601
8100	623
8100	624

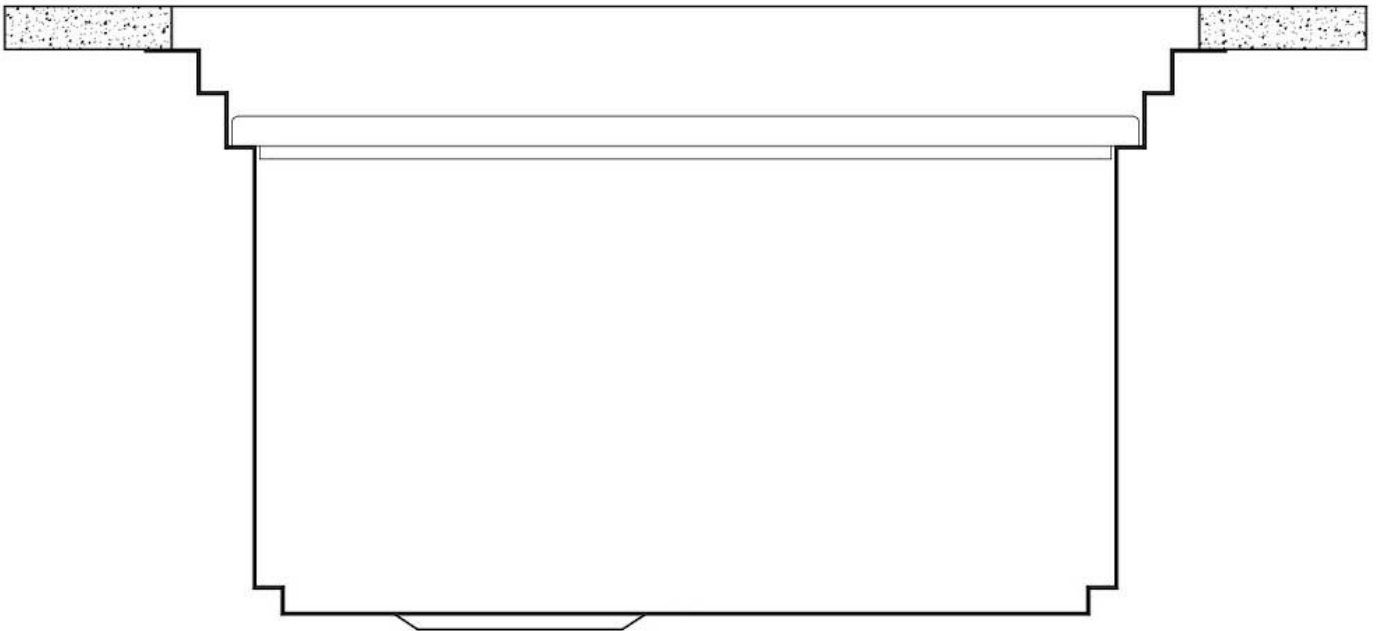

## Happy Hour Level 4

Compatible accessories:

8100 600

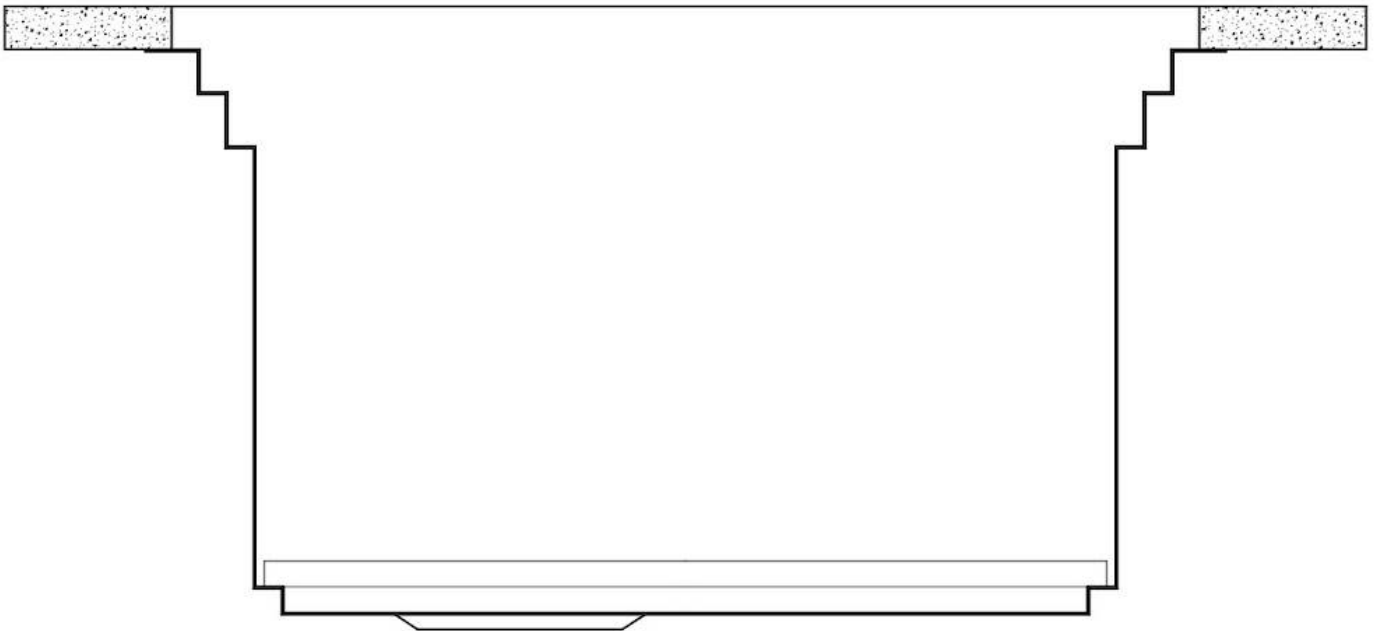

8100 600

8100 600

8100 600

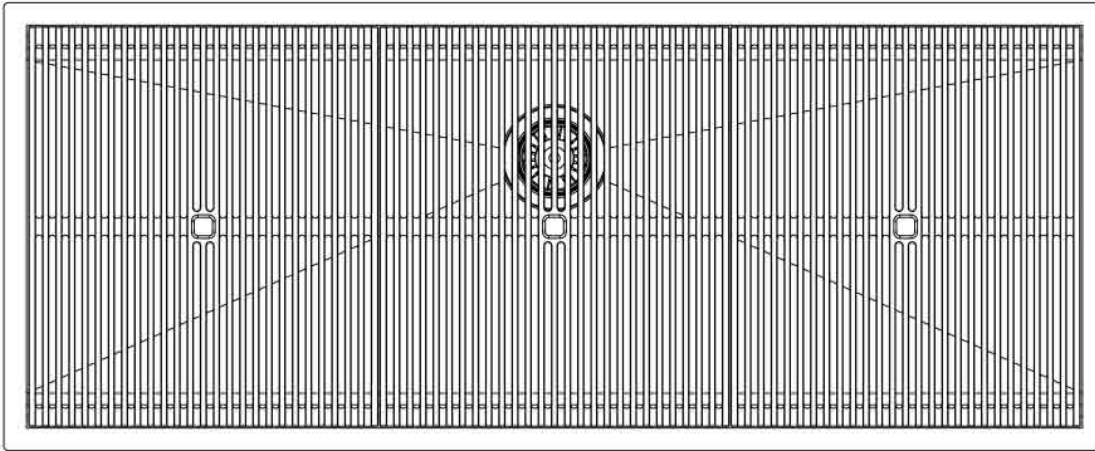

Edge positioning

Bottom positioning

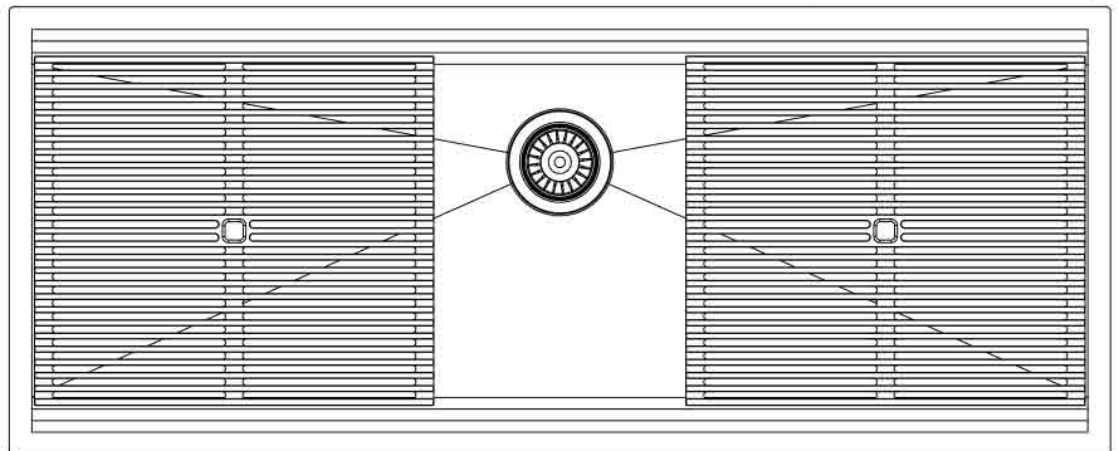

8100 600

8100 600

## GALLERY

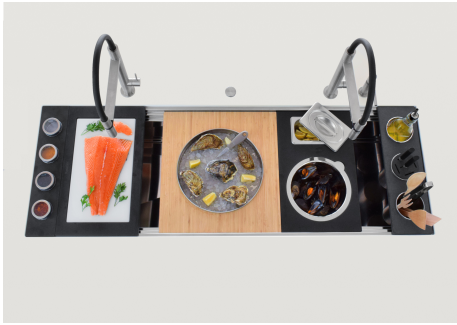
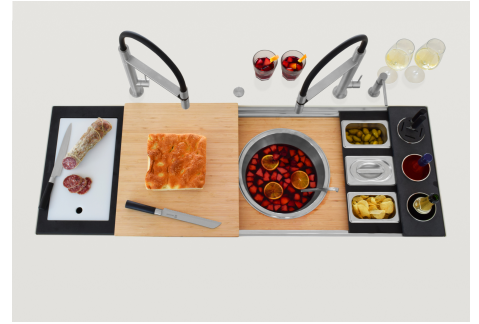

## OPTIONAL ACCESSORIES



**2 Bowls set**  
8100 623



**3 Bottles-holder set**  
8100 621



**3 Bottles-holder set**  
8100 626



**3 Bowls set**  
8100 622



**3 Bowls set**  
8100 624



**4 Spices-holder set**  
8100 620



**4 Spices-holder set**  
8100 625



**Chopping Board**  
8642 000



**Chopping Board**  
8631 300



**Grating kit complete with ring support and food collection tray**  
8159 101

\* only in combination with the accessory  
8100 627 or 8644 101



**HDPE + Black Twin chopping board**  
8100 627



**Kit bowl Ø30 cm with bamboo support**  
8200 601



**Kit multi-bowl**  
8100 628



**Knives-holder**  
8100 030

\* only in combination with the accessory  
8100 621 or 8100 626

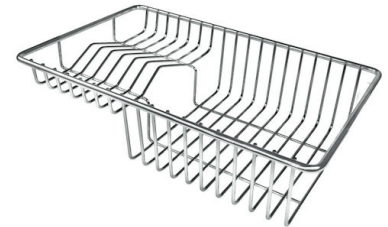

**Stainless Steel dishes holder**  
8100 303

\* only in combination with the accessory  
8100 627 or 8644 101



**Stainless steel perforated pan**  
8151 000

\* only in combination with the accessory  
8100 627 or 8644 101



**Steel tray**  
1778 000

\* only in combination with the accessory  
8200 601



**Twin Chopping Board**  
8644 101



**White bowl**  
8153 100



**Bamboo chopping board**  
8200 002



**Black Grid**  
8100 600



**PVD Gun Metal automatic kit for waste-fitting**  
8407 136



**Waste disposer throat PVD Gun Metal**  
8669 046

## RECOMMENDED PAIRINGS

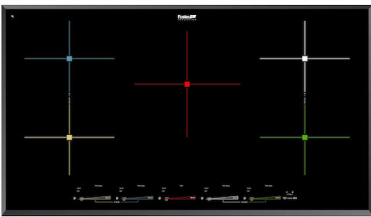

**Milano Induction Cooktop 5 Plate**  
7390 945



**Faucet Capri Gun Metal**  
8467 605

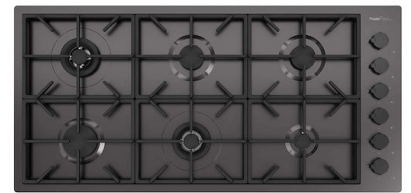

**Milano Cooktop Gun Metal 6 burners**  
7639 906